

QUATTRO

All drawings shown with standard armrest 400 and 420

www.sits.eu
JULY 2012

ARMCHAIR 70

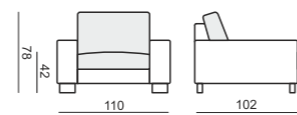

ARMCHAIR 70 LEFT (or RIGHT)

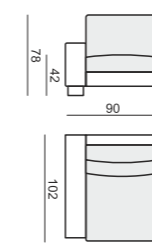

ARMCHAIR 70 without ARMRESTS

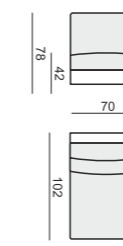

2 SEATER 70

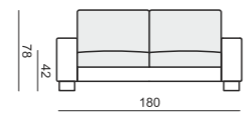

2 SEATER 70 LEFT (or RIGHT)

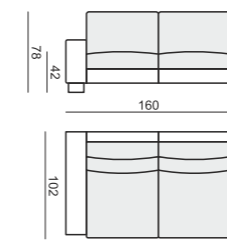

2 SEATER 70 without ARMRESTS

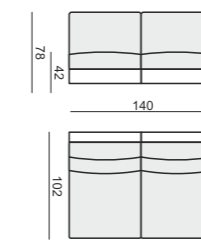

3 SEATER XL 70

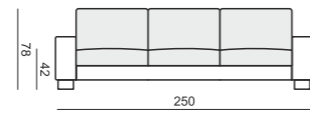

3 SEATER XL 70 LEFT (or RIGHT)

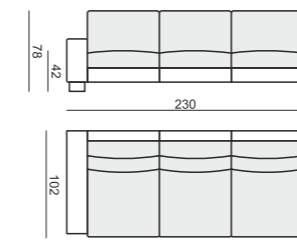

3 SEATER XL 70 without ARMRESTS

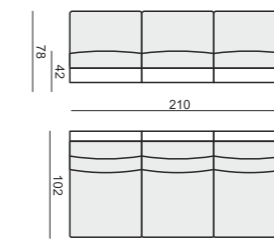

CHAISEONGUE 70 LEFT (or RIGHT)

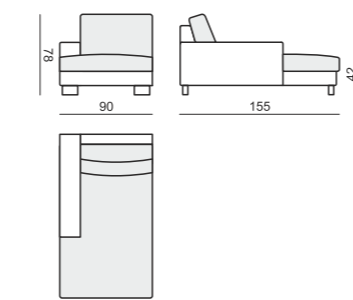

BENCH 70 LEFT (or RIGHT)

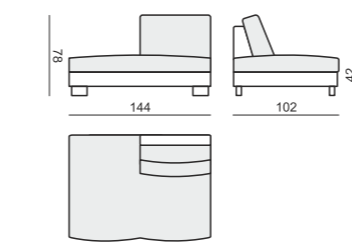

FOOTSTOOL 70x53

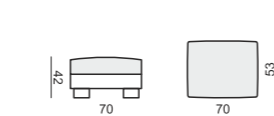

SOFA BED

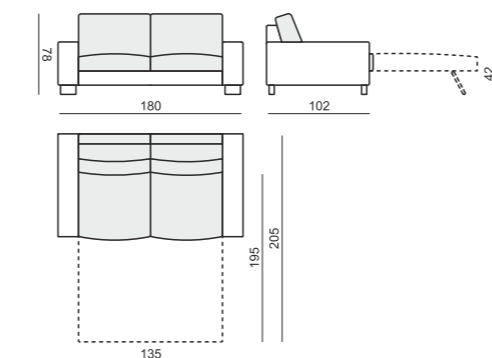

HEADREST L-60 x Ø16

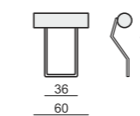

ARMCHAIR 90

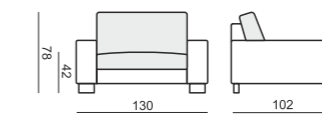

ARMCHAIR 90 LEFT (or RIGHT)

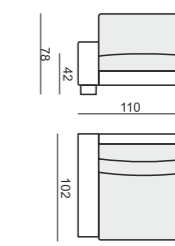

ARMCHAIR 90 without ARMRESTS

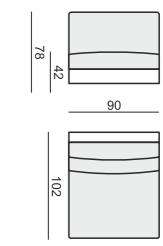

3 SEATER 90

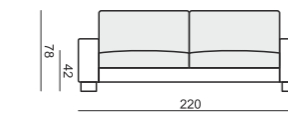

3 SEATER 90 LEFT (or RIGHT)

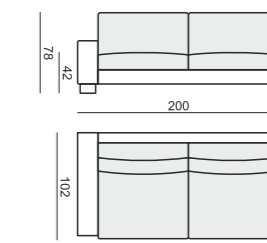

3 SEATER 90 without ARMRESTS

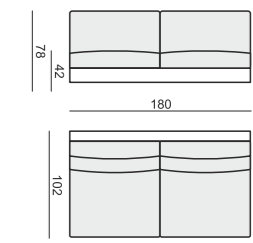

CHAISEONGUE 90 LEFT (or RIGHT)

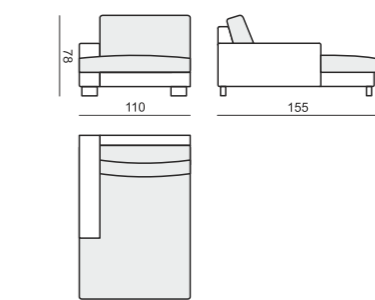

CHAISEONGUE 90 LONG LEFT (or RIGHT)

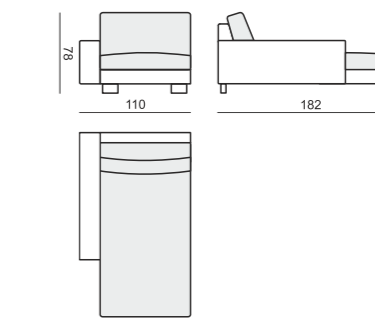

FOOTSTOOL 90x53

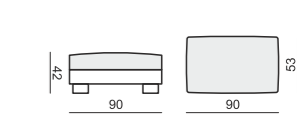

FOOTSTOOL 90x90

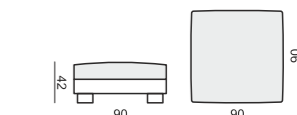

CORNER 45° No.300

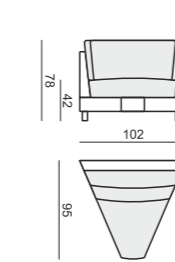

CORNER 90° No.310

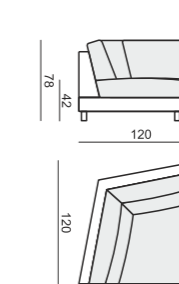

CORNER 90° No.320

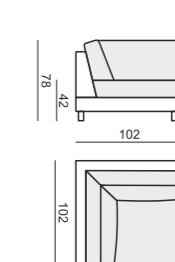

CORNER RIGHT (or LEFT) No.330

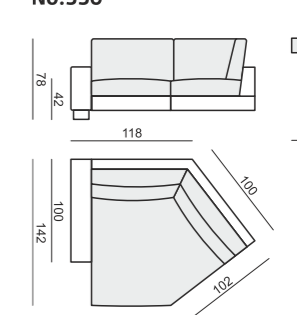

HEADREST L-80 x Ø16 No.330

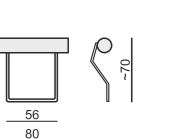

ARMREST 400

100 x 20 x 42 cm

available with feet:
no. 42, no. 47, no. 51,
no. 53, no. 60, no. 60A,
no. 61A

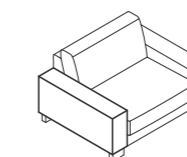

ARMREST 420

100 x 20 x 47 cm

available with feet:
no. 42, no. 47, no. 51,
no. 53, no. 60, no. 60A,
no. 61A

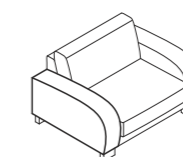

ARMREST 450

100 x 12 x 47 cm

available with feet:
no. 47, no. 51, no. 53,
no. 60A

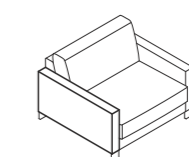

ARMREST 460

100 x 27 x 42 cm

available with feet:
no. 42, no. 47, no. 51,
no. 53, no. 60, no. 60A,
no. 61, no. 61A

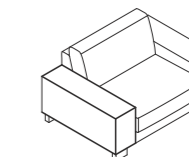

ARMREST 470

100 x 27 x 42 cm

(not available for sofa bed)

available with feet:
no. 42, no. 47, no. 51,
no. 53, no. 60, no. 60A,
no. 61, no. 61A

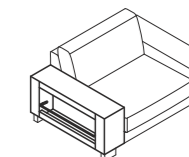

ENDPART

LEFT (or RIGHT)

98 x 55 x 2,5 cm

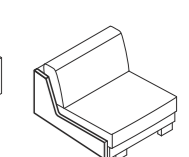

SITS reserves the right to change construction of products and components used due to improving durability of product and customer satisfaction without any further notice. Explicit ±2 cm tolerance of all elements sizes. www.sits.eu JULY 2012



QUATTRO

www.sits.eu
JULY 2012

All drawings shown with standard armrest 400 and 420

www.sits.eu
JULY 2012

SITS reserves the right to change construction of products and components used due to improving durability of product and customer satisfaction without any further notice. Explicit ±2 cm tolerance of all elements sizes.

www.sits.eu
JULY 2012

SET 1 LEFT (or RIGHT)
CHAISELONGUE 70 LEFT (or RIGHT)
+ 2 SEATER 70 RIGHT (or LEFT)

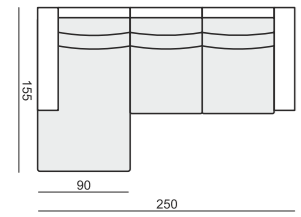

SET 2 LEFT (or RIGHT)
CHAISELONGUE 90 LEFT (or RIGHT)
+ 3 SEATER 90 RIGHT (or LEFT)

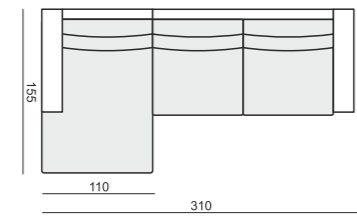

SET 9 RIGHT (or LEFT)
CHAISELONGUE 70 LEFT (or RIGHT) + 2 SEATER 70 without ARMRESTS
+ CORNER 45° + 2 SEATER 70 RIGHT (or LEFT)

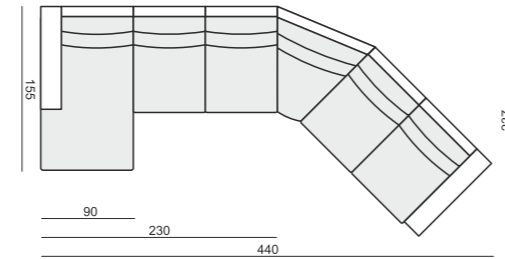

SET 10 RIGHT (or LEFT)
CHAISELONGUE 90 LEFT (or RIGHT) + 3 SEATER 90 without ARMRESTS
+ CORNER 45° + 3 SEATER 90 RIGHT (or LEFT)

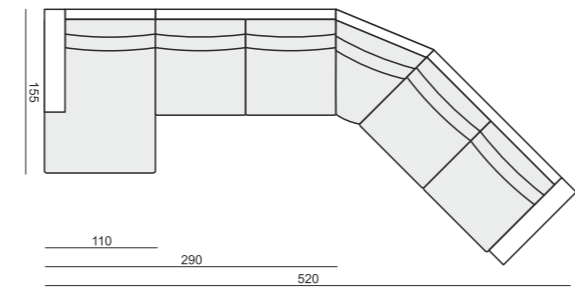

SET 3 RIGHT (or LEFT)
2 SEATER 70 LEFT (or RIGHT)
+ CORNER 45° + ARMCHAIR 70 RIGHT (or LEFT)

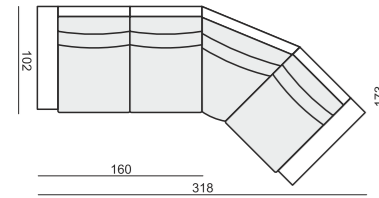

SET 4 RIGHT (or LEFT)
3 SEATER 90 LEFT (or RIGHT)
+ CORNER 45° + ARMCHAIR 90 RIGHT (or LEFT)

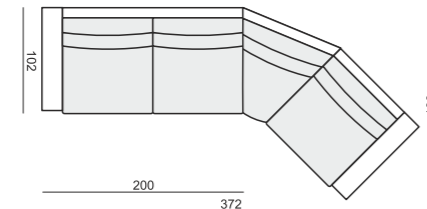

SET 11 RIGHT (or LEFT)
CHAISELONGUE 70 LEFT (or RIGHT) + 2 SEATER 70 without ARMRESTS
+ CORNER 45° + ARMCHAIR 70 RIGHT (or LEFT)

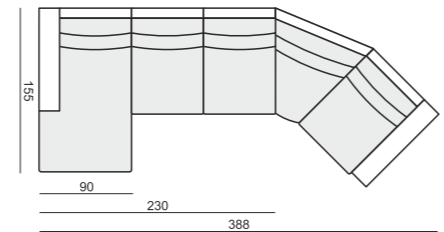

SET 12 RIGHT (or LEFT)
CHAISELONGUE 90 LEFT (or RIGHT) + 3 SEATER 90 without ARMRESTS
+ CORNER 45° + ARMCHAIR 90 RIGHT (or LEFT)

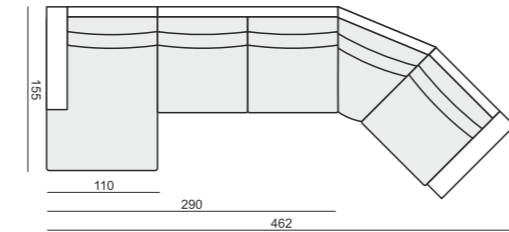

SET 5
2 SEATER 70 LEFT
+ CORNER 90° + 2 SEATER 70 RIGHT

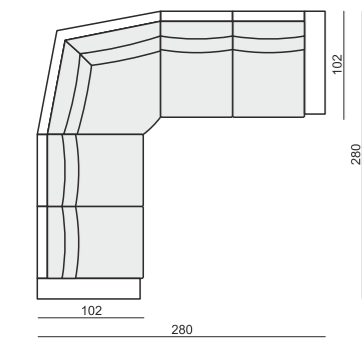

SET 6
3 SEATER 90 LEFT
+ CORNER 90° + 3 SEATER 90 RIGHT

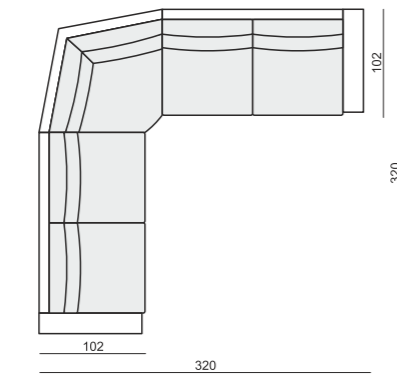

SET 13 RIGHT (or LEFT)
3 SEATER 90 LEFT (or RIGHT)
+ CORNER 90° + 2 SEATER 70 RIGHT (or LEFT)

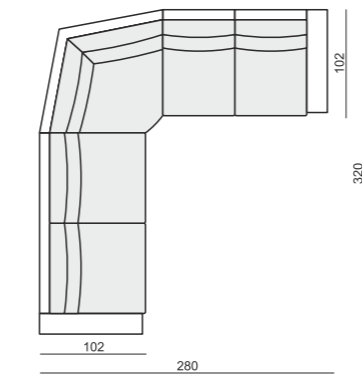

SET 14 RIGHT (or LEFT)
3 SEATER 90 LEFT (or RIGHT)
+ CORNER 90° + BENCH 70 RIGHT (or LEFT)

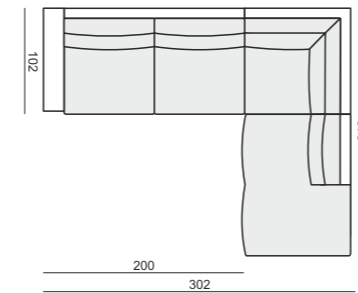

SET 7
2 SEATER 70 LEFT
+ CORNER 90° + 2 SEATER 70 RIGHT

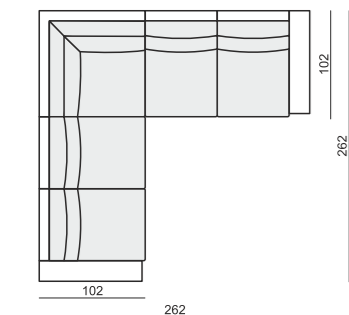

SET 8
3 SEATER 90 LEFT
+ CORNER 90° + 3 SEATER 90 RIGHT

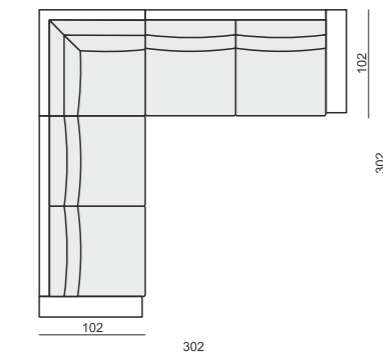

SET 15 RIGHT (or LEFT)
2 SEATER 70 LEFT (or RIGHT)
+ CORNER 90° + BENCH 70 RIGHT (or LEFT)

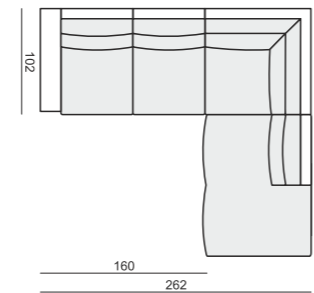

SET 16 LEFT (or RIGHT)
CHAISELONGUE 90 LONG LEFT (or RIGHT)
+ 3 SEATER 90 RIGHT (or LEFT)

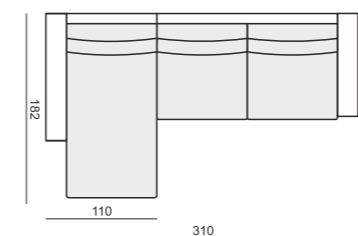

UPHOLSTERY FABRIC: FC - fix cover and LEATHER

FEET

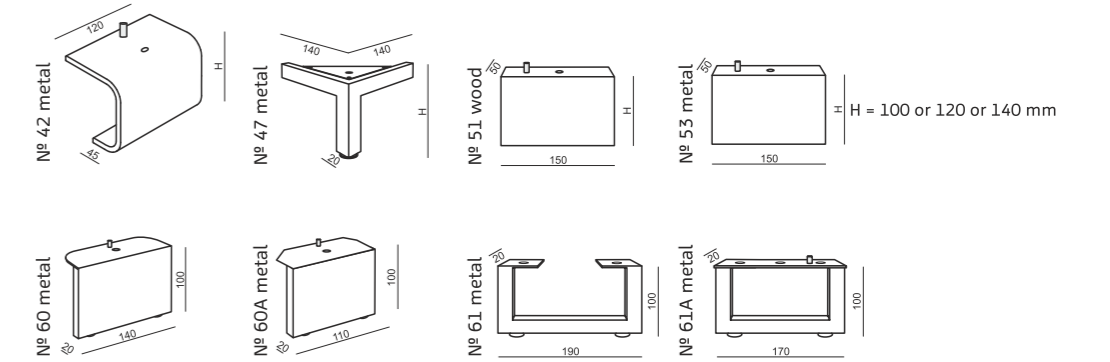

STANDARD COMFORT (for fabric and leather covers)

LUX COMFORT (for fabric cover only)